



TECHNICAL DETAILS

ADA Compliance: Yes
Access Hole Diameter: 5"
Handle Turn Angle: 115°
Installation Type: Wall Mounted
Primary Material: Brass
Valve Material: Ceramic

CODES & STANDARDS

ASME A112.181/ CSA B1251, ASME 112.18.2/ CSA B125.2, ANSI NSF, CEC,
Watersense 61 Sect. 9, State of MA.



WARRANTY

Mechanical Warranty: 10 Years from date of purchase.
Finish Warranty: See catalog for further information.

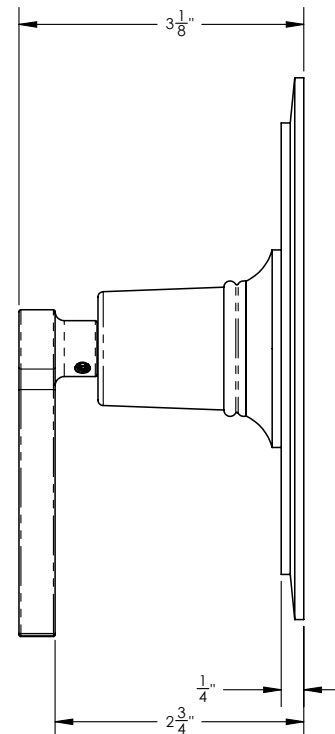
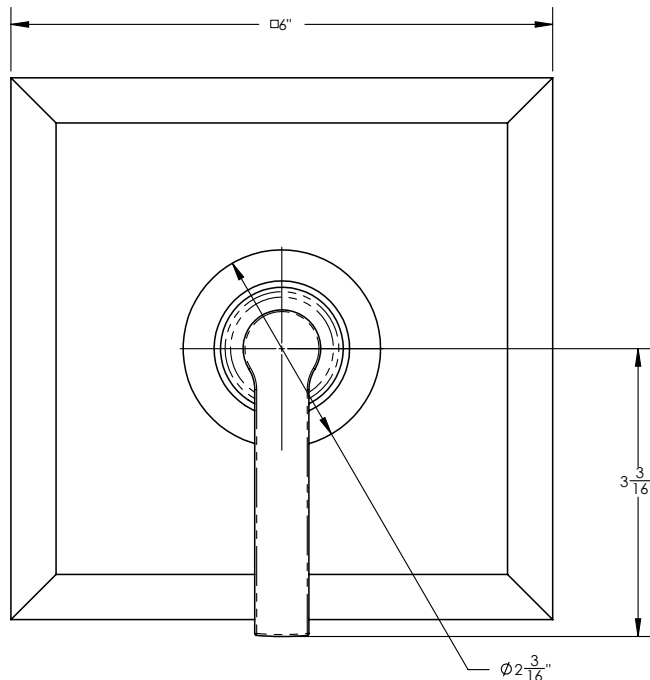



TECHNICAL DETAILS

ADA Compliance: No
Primary Material: Brass

PRODUCT FEATURES

- Hose Length: 59"

CODES & STANDARDS



WARRANTY

Mechanical Warranty: 10 Years from date of purchase.
Finish Warranty: See catalog for further information.

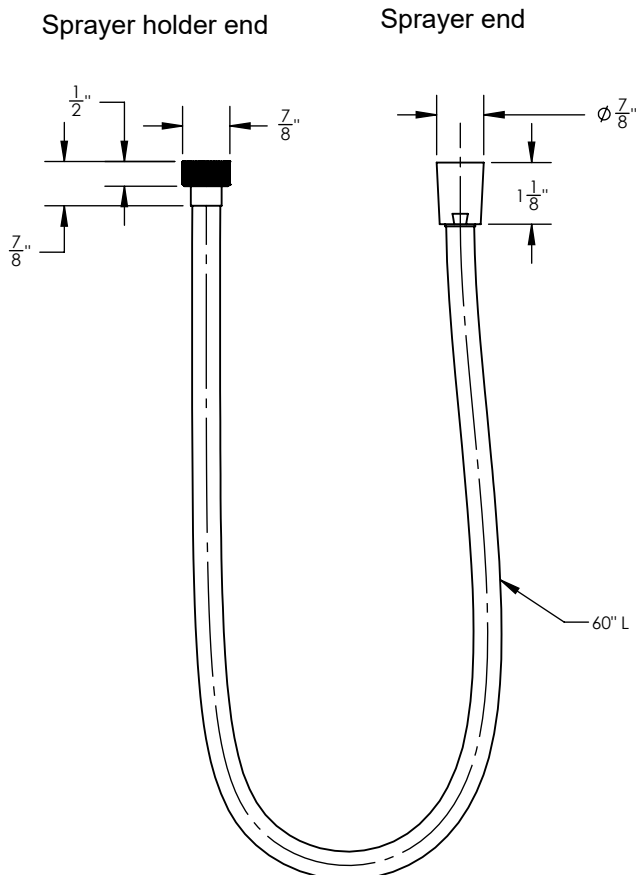

Atmosphyre

2706 New Scotland Road
Voorheesville, NY 12186
518-655-01286

3" Round Hand Shower

www.atmosphyre.com
james@atmosphyre.com



TECHNICAL DETAILS

ADA Compliance: No
Primary Material: Brass
Hand Shower Flow Restriction: 1.8 GPM

PRODUCT FEATURES

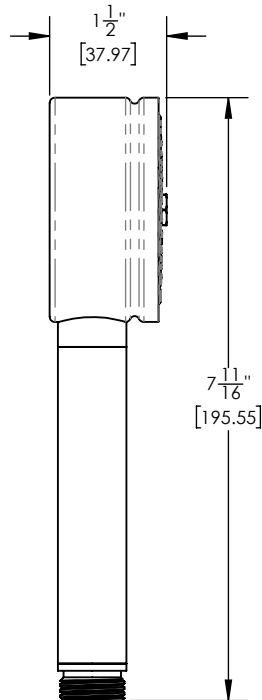

WARRANTY

Mechanical Warranty: 10 Years from date of purchase.
Finish Warranty: See catalog for further information.

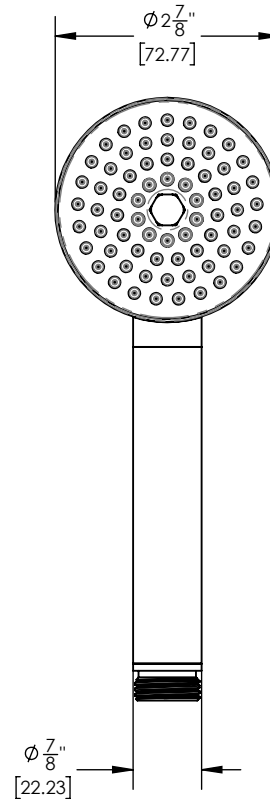

CODES & STANDARDS



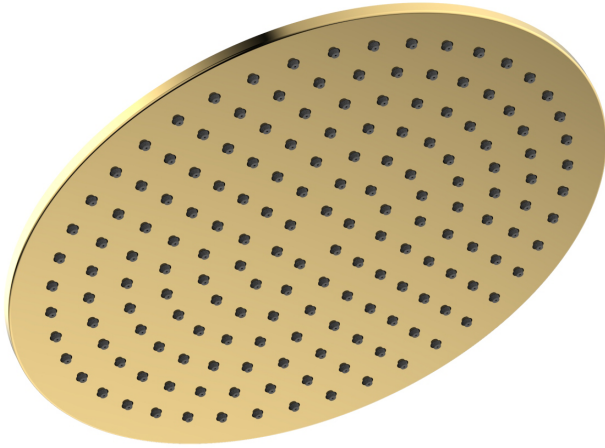

■ TECHNICAL DETAILS

ADA Compliance: No
Flow Restriction: 1.8 gpm

■ PRODUCT DIMENSIONS

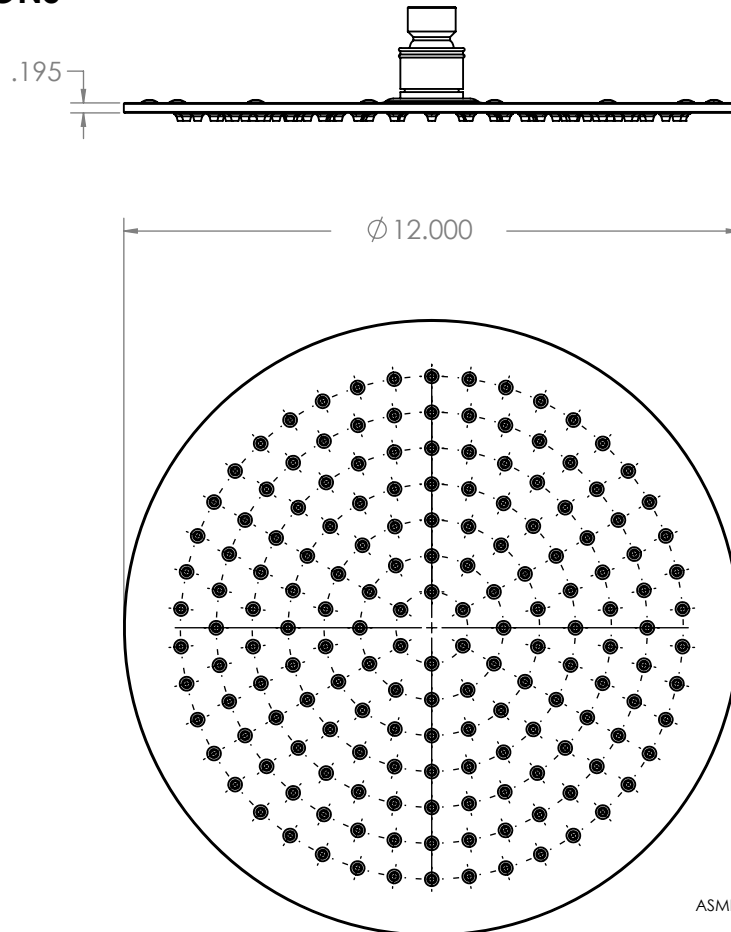

CODES & STANDARDS

ASME A112.181 / CSA B1251, ASME 112.18.2 / CSA B125.2, ANSI NSF, CEC

WARRANTY

Mechanical Warranty: 10 Years from date of purchase.
Finish Warranty: See catalog for further information.