

# Atmosphyre

2706 New Scotland Road  
Voorheesville, NY 12186  
518-655-01286

Shower plate and trim

www.atmosphyre.com  
james@atmosphyre.com



## TECHNICAL DETAILS

ADA Compliance: Yes  
Access Hole Diameter: 5"  
Handle Turn Angle: 115°  
Installation Type: Wall Mounted  
Primary Material: Brass  
Valve Material: Ceramic

## CODES & STANDARDS

ASME A112.181/ CSA B1251, ASME 112.18.2/ CSA B125.2, ANSI NSF, CEC,  
Watersense 61 Sect. 9, State of MA.



## WARRANTY

Mechanical Warranty: 10 Years from date of purchase.  
Finish Warranty: See catalog for further information.

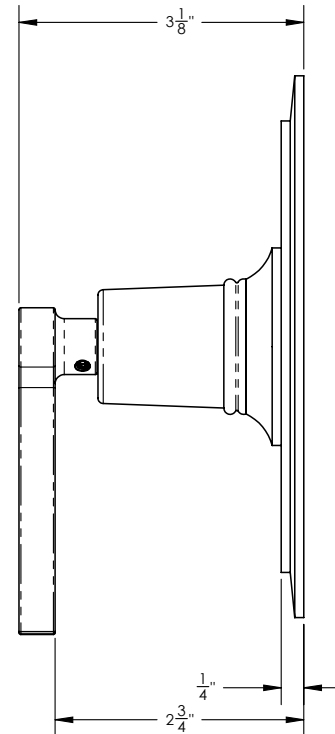
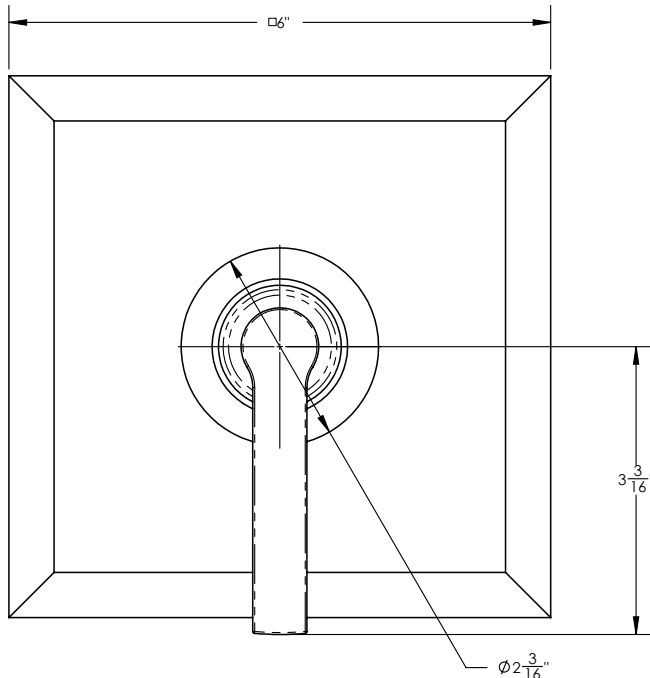



### TECHNICAL DETAILS

ADA Compliance: No  
Primary Material: Brass

### PRODUCT FEATURES

- Hose Length: 59"

### CODES & STANDARDS



### WARRANTY

Mechanical Warranty: 10 Years from date of purchase.  
Finish Warranty: See catalog for further information.

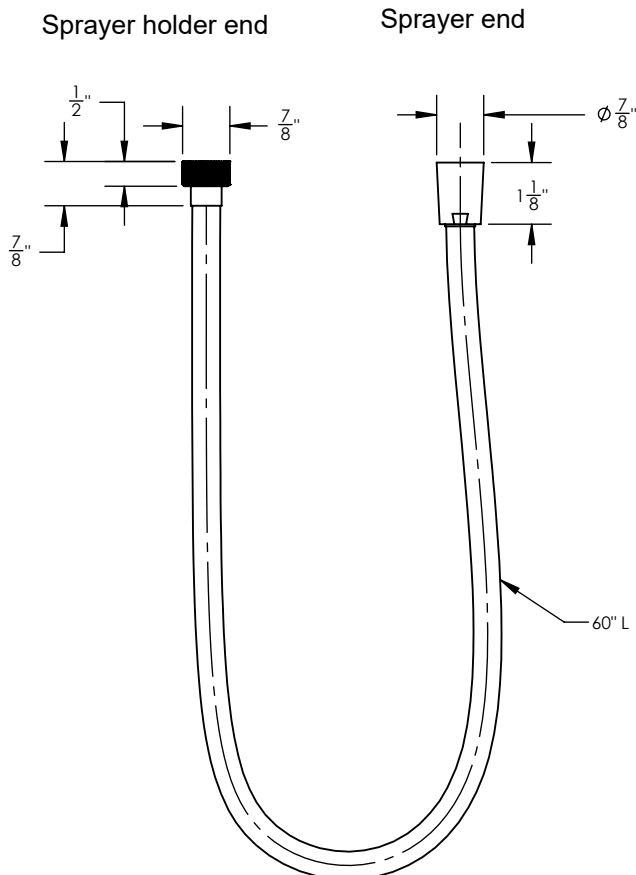

# Atmosphyre

2706 New Scotland Road  
Voorheesville, NY 12186  
518-655-01286

## 3" Round Hand Shower

www.atmosphyre.com  
james@atmosphyre.com



### TECHNICAL DETAILS

ADA Compliance: No  
Primary Material: Brass  
Hand Shower Flow Restriction: 1.8 GPM

### PRODUCT FEATURES

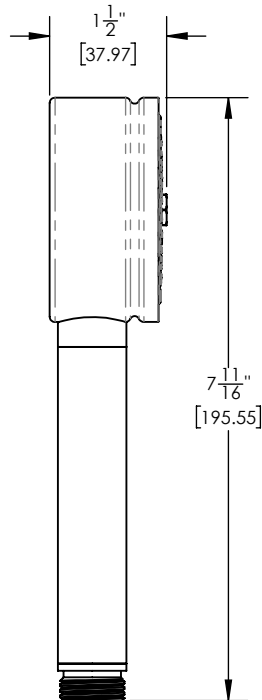

### WARRANTY

Mechanical Warranty: 10 Years from date of purchase.  
Finish Warranty: See catalog for further information.

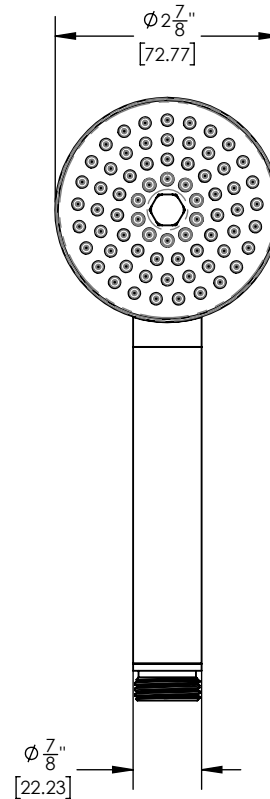

### CODES & STANDARDS





### TECHNICAL DETAILS

ADA Compliance: No  
Flow Restriction: 1.8 gpm

### PRODUCT DIMENSIONS

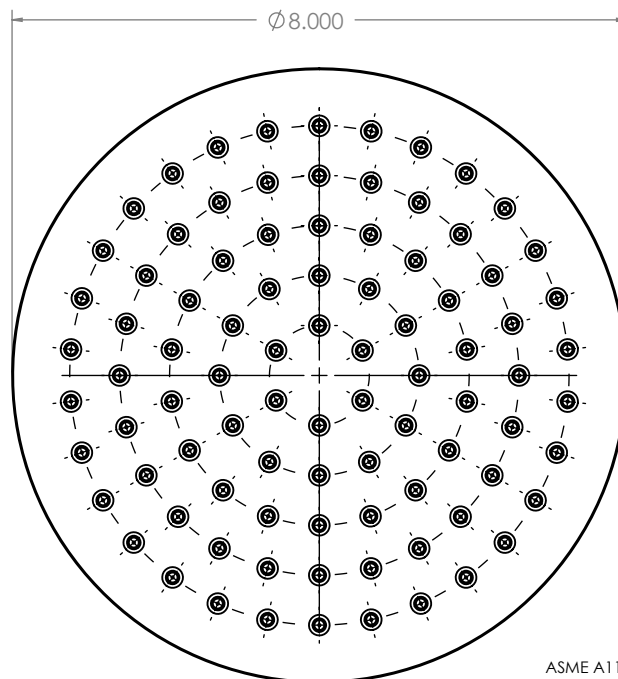
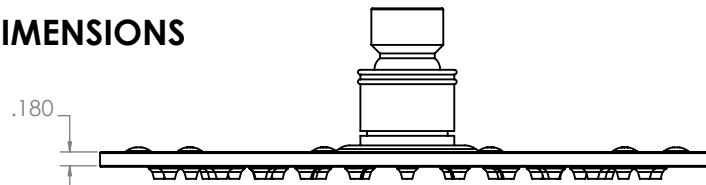

**CODES & STANDARDS**

ASME A112.181/ CSA B1251, ASME 112.18.2/ CSA B125.2, ANSI NSF, CEC

### WARRANTY

Mechanical Warranty: 10 Years from date of purchase.  
Finish Warranty: See catalog for further information.